



Congratulations on your Guide Gear® purchase.

Enjoy your new Guide Gear® item with confidence, knowing it has been designed and built to deliver dependable quality and performance at an exceptional value.

Item #181167 Guide Gear® Heavy Duty Grill
Item #181168 Guide Gear® XL Heavy Duty Grill



For assistance with your product, please contact Sportsman's Guide customer service at 1-800-888-3006 Mon.-Fri. 7:00am to 7:00pm, Sat.-Sun. 9:00am to 6:00pm CST or go to sportsmansguide.com/customerservice/contactus











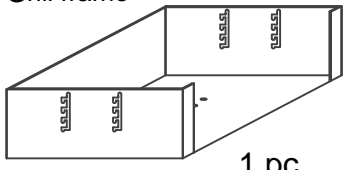

WARNINGS and CAUTIONS:

- Read and understand all warnings, cautions, assembly, installation and use instructions prior to assembling, installing or using this product. Failure to follow all warnings, cautions and instructions may result in serious injury and/or damage to property.
- ⚠ **WARNING:** This package contains small parts that can pose a choking hazard. Keep away from children and pets.
- ⚠ **CAUTION:** Edges may be sharp. Handle parts with caution and wear gloves during unpacking and assembly.
- Confirm all parts are present before assembly. If any part is missing or damaged, please contact Sportsman's Guide customer service for assistance before assembly.
- ⚠ **CAUTION:** For best stability and safety it is recommended to set the support pole in a concrete base. Please consult a professional regarding the best installation method for your particular needs. Improper installation can result in injury and/or damage to property.
- For outdoor use only. NEVER use in any building, garage, other enclosures or under any structure. This grill is NOT for commercial use.
- NEVER use on wooden or other flammable surfaces.
- NEVER use under an overhang or near any unprotected combustible materials.
- AVOID using near or under overhanging trees and shrubs.
- ALWAYS use this product on a hard, level, non-combustible surface such as concrete, rock or stone.
- ALWAYS use in accordance with all applicable local, state and federal codes.
- NEVER attempt to modify this product or subject it to an installation or use for which it was not designed. Doing so may result in damage and/or serious injury.
- Always be aware of the environment and ensure that the product is used in a safe and responsible manner.
- ⚠ **CAUTION:** During and after grilling, grill components become extremely HOT and can remain hot even after coals appear to have extinguished. Use extreme care.
- ⚠ **CAUTION:** Keep children and pets away from the grill.
- NEVER handle the grill or re-position the cooking grate with unprotected hands.
- The warnings, cautions, and instructions in this manual cannot cover all possible conditions or situations that could occur. Exercise common sense and caution when using this product.

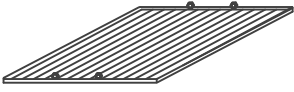
TOOLS REQUIRED (not included):

- Phillips Head Screwdriver
- 18mm or Adjustable Wrench

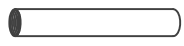
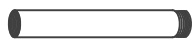
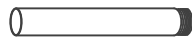
PARTS LIST:

<p>A. Chassis</p>  <p>1 pc</p>	<p>B. Grill frame</p>  <p>1 pc</p>	<p>C. Cross Bolts</p>  <p>4 pcs</p>	<p>D. Flat spacer</p>  <p>4 pcs</p>	<p>E. Spring Washer</p>  <p>4 pcs</p>
<p>F. Nuts</p>  <p>4 pcs</p>	<p>G. Grate</p>  <p>1 pc</p>	<p>H. Handle</p>  <p>2 pcs</p>	<p>I. Spring Washer</p>  <p>4 pcs</p>	<p>J. Small Nuts</p>  <p>4 pcs</p>
<p>K. End pole</p>  <p>1 pc</p>	<p>L. Middle pole</p>  <p>1 pc</p>	<p>M. Top pole</p>  <p>1 pc</p>	<p>N. Thumb screw</p>  <p>1 pc</p>	

ASSEMBLY INSTRUCTIONS:

Do not fully tighten bolts until each step is complete.

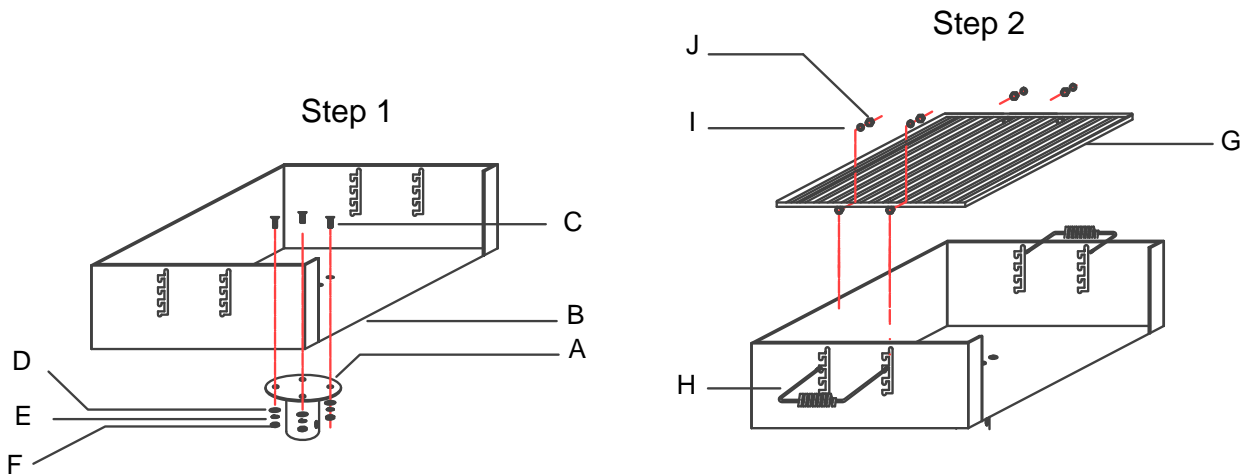

ASSEMBLY INSTRUCTIONS (continued):

Step 3

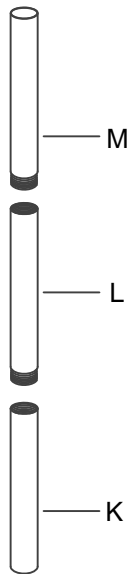

Step 4

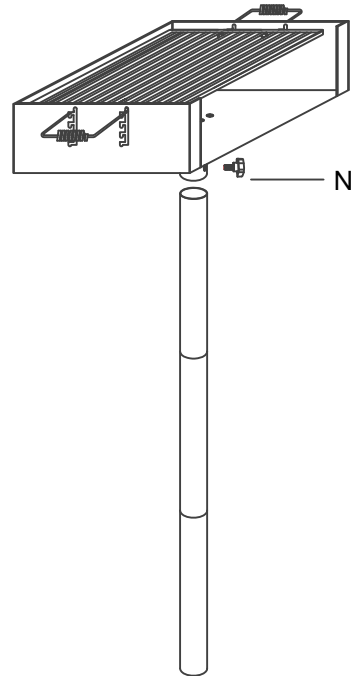

INSTALLATION:

For best stability and safety it is recommended to set the support pole in a concrete base. Please consult a professional regarding the best installation method for your particular needs. Improper installation can result in injury and/or damage to property.